

# BARREL SAUNA EMIL

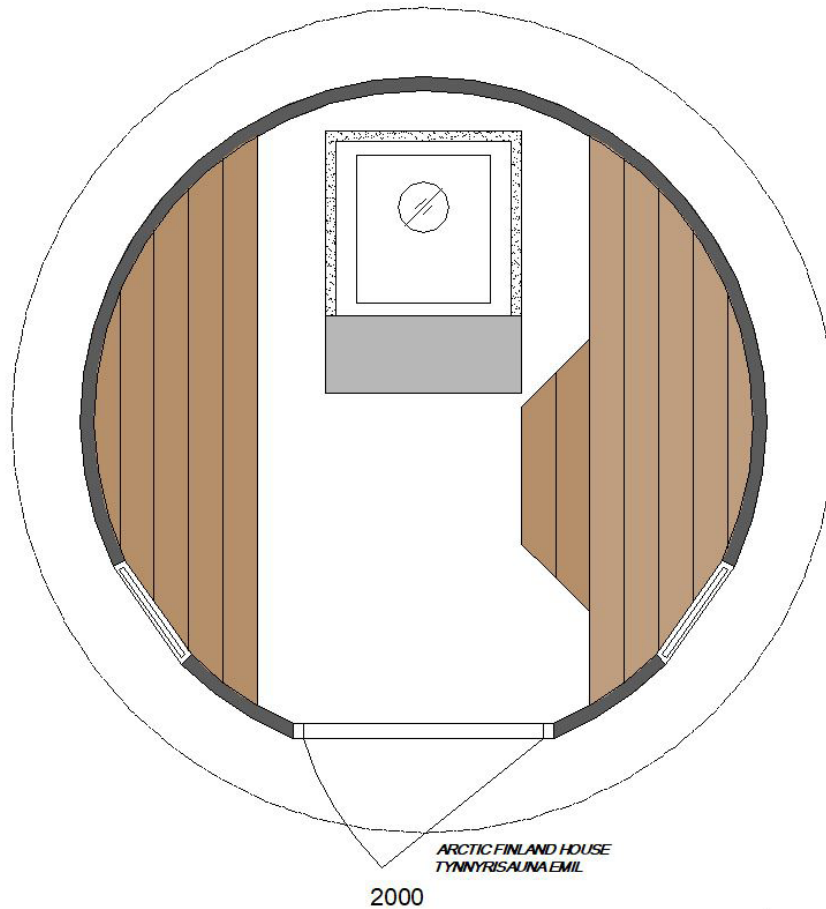

## CONTENT:

1. Technical information
2. Drawing
3. Delivery
4. Surface treatment of wood

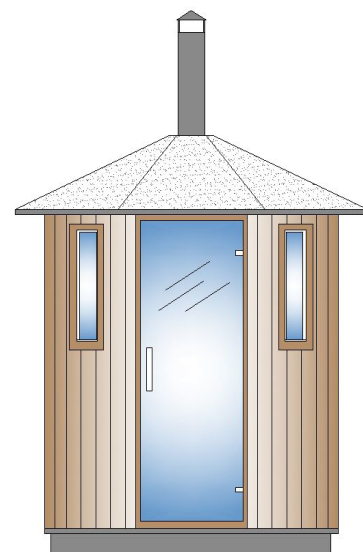

# 1. Technical information



## Tynnyrisauna Emil

- Emil complete barrel sauna, with room for 3 to 4 people
- The material is heat-treated 40mm spruce.
- The roofing consists of pre-fixed black felt shingles.
- The sauna has two fixed windows.
- The sauna benches are made of heat-treated pine.
- The entrance door is a pine door with a window and a lock.

- Barrel sauna on skids
- Windows and entrance door
- Sauna benches and floor grate
- Sauna stove, stove stones, chimney and water tank
- Installation accessories
- Instructions

- Space                      3 - 4 person
- Height                     2100 mm
- Diameter                 2000 mm
- Weight                    650 kg
- Windows                 2 pcs
  
- Door dimension         700 x 1870 mm

## 2. Drawing

### Barrel sauna Emil

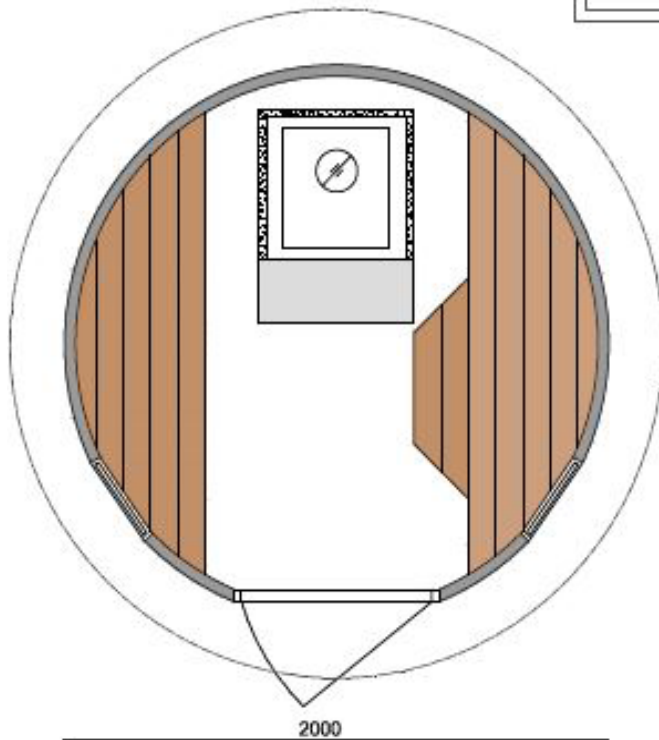
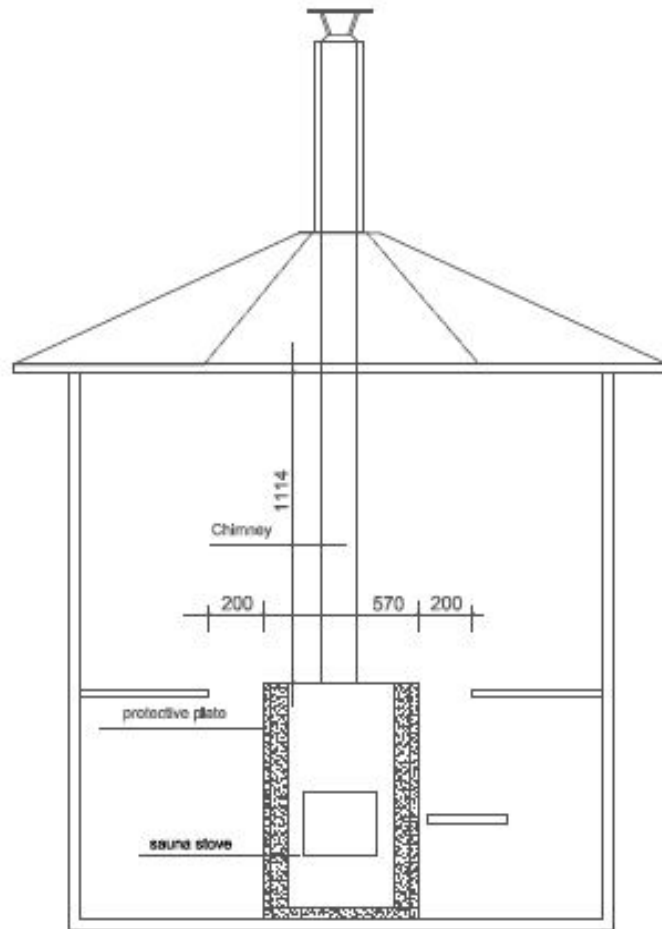
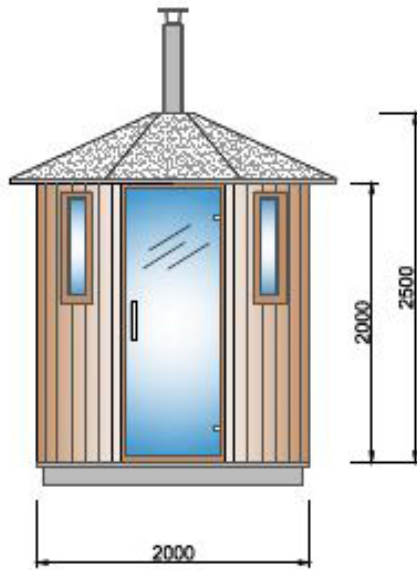

#### Barrel sauna

Material: spruce 40 mm  
Roofing felt  
Two windows, door with a lock  
Sauna benches, wooden floors  
Sauna stove, stones, chimney

### 3. Toimitus

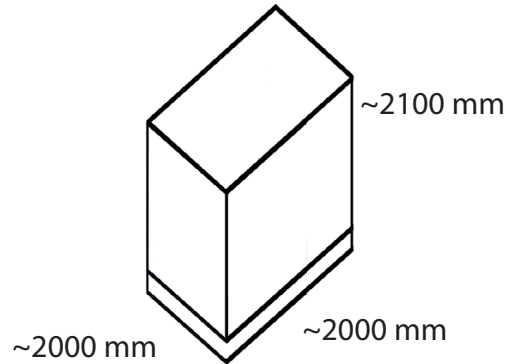
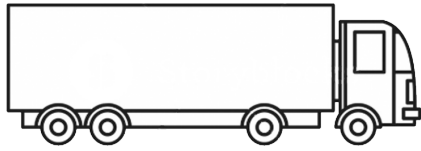

Barrel sauna dimension: 2,0m x 2,1m / 650kg

Barrel sauna Emil will be delivered on the date stated in the order unless otherwise agreed or indicated. The product is brought to the end of a truck-driven road / site boundary. The product is packed on a pallet and protected with plastic. The recipient is expected to be present. Any transport damage must be recorded in the consignment note.

The customer is responsible for any permit procedures for the product and ascertains whether a building permit or notice to the local building control authority is required

## 4. Surface treatment of wood

The products are made of natural, good quality timber, which is an excellent building material. Thanks to its slow growth, the wood is firm, dense and straight-grained. There are few branches and the proportion of heartwood is large.

Wood is a natural material which tends to change with the weather and environmental conditions. Cracks, colour differences and other structural changes do not make the wood faulty.

The timber of the products is unprocessed. The products are stored and packed on pallets to protect them from the weather. Wood is very sensitive to sunlight and moisture, and therefore we recommend that you treat all wood components immediately or at the latest after the building is erected. The best time is during partly cloudy dry weather (over +5 degrees).

First, use a colourless wood preservative to prevent mould and blue stain. Then finish with a clear / translucent / coloured wood preservative coating or an opaque paint.

All surface treatment agents should be breathable and should not form a dense, non-breathable film on the surface of the wood. Also treat doors and windows with care on both sides.

Make sure you get the right treatment agent from your dealer. Check the wooden structures every year and perform maintenance painting on time.

