

# CAPRI AND TOSCANA 10m<sup>2</sup>



## CONTENT:

1. Technical information and delivery contents
2. Accessories
3. Drawing
  - 3.1 Drawing
4. Foundations
5. Delivery and installation
6. Surface treatment of wood

ROMA

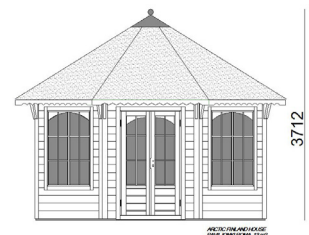

RAVENNA



# 1. Technical information

## CONTENTS

Pavillon ROMA 13 m2:

- Wall and roof elements
- Windows and entrance door
- Floor 28 mm
- Installation accessories
- Instructions

## TECHNICAL INFORMATION:

- |          |                    |                    |                |
|----------|--------------------|--------------------|----------------|
| • Modell | Octagonal pavillon | • Windows          | 4 pcs          |
| • Size   | 13 m2              | • Window dimension | 1085 x 1365 mm |
| • Heigh  | 3 712mm            | • Door dimension   | 1085x 1900 mm  |
| • Weight | 1 580 kg           |                    |                |

Pavillon RAVENNA 13 m2:

- Wall and roof elements
- Floor 28 mm
- Installation accessories
- Instructions

## 2. Accessories

- Fish boards
- Copper pan
- Frying pan
- Reindeer hides, 5 pcs
- Lapland product package
- Plates and cutlery, for 6 persons
- Large and small drinking cups, for 6 persons
- Trivet and napkin holder
- Pot-holders and oven mittens
- Clock and visitors' book
- Schnapps binoculars and thermometer
- Flower box
- Extension bench
- Grill table
- Grill table extension
- Smoke pipe extension
- Storage box
- Light cable
- Glass roof, safety glass
- Roof insulation set
- Wall insulation set
- Floor insulation set
- Seat cushion set
- Curtain set
- Roofing felt colour options: red, black, grey, brown

### Roofing felt

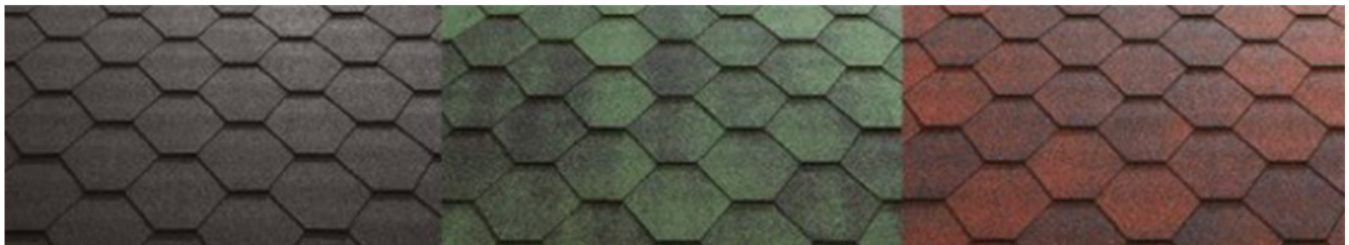

### 3. Drawing ROMA



PAVILION ROMA 13 m<sup>2</sup>

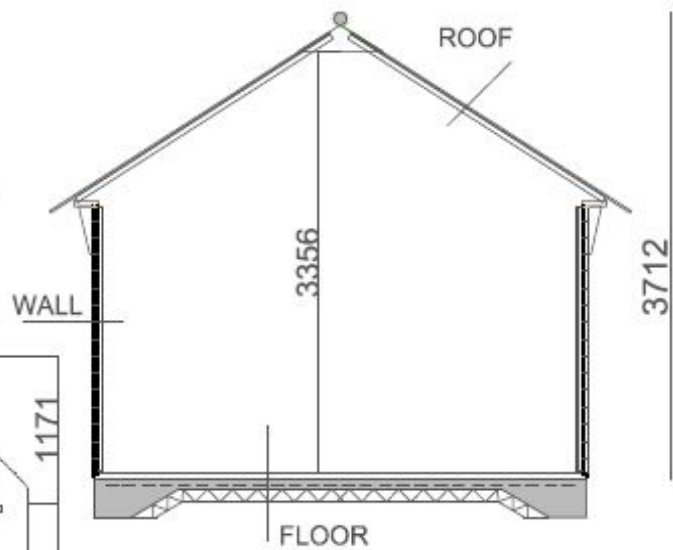
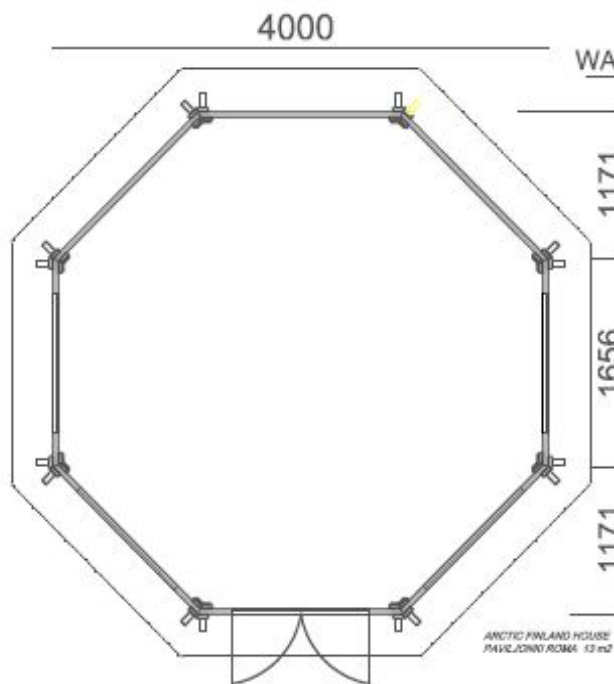

#### ROOF

Roofing felt  
Panel 18 x 145  
Frame 45 x 45

#### WALL

Timber panel 45 x 145

#### FLOOR

Concrete slab 80 mm  
Steel mesh embedded in concrete slab  
( B500K 4-150)  
Cellular plastic / styrofoam 100 mm  
Compacted gravel 200 mm ( 0-16 mm)  
Base frame 45 x 95 pressure impregnated  
( Bitumen felt under base frame )

# 3.1 Drawing RAVENNA

PAVILION RAVENNA 13 m<sup>2</sup>

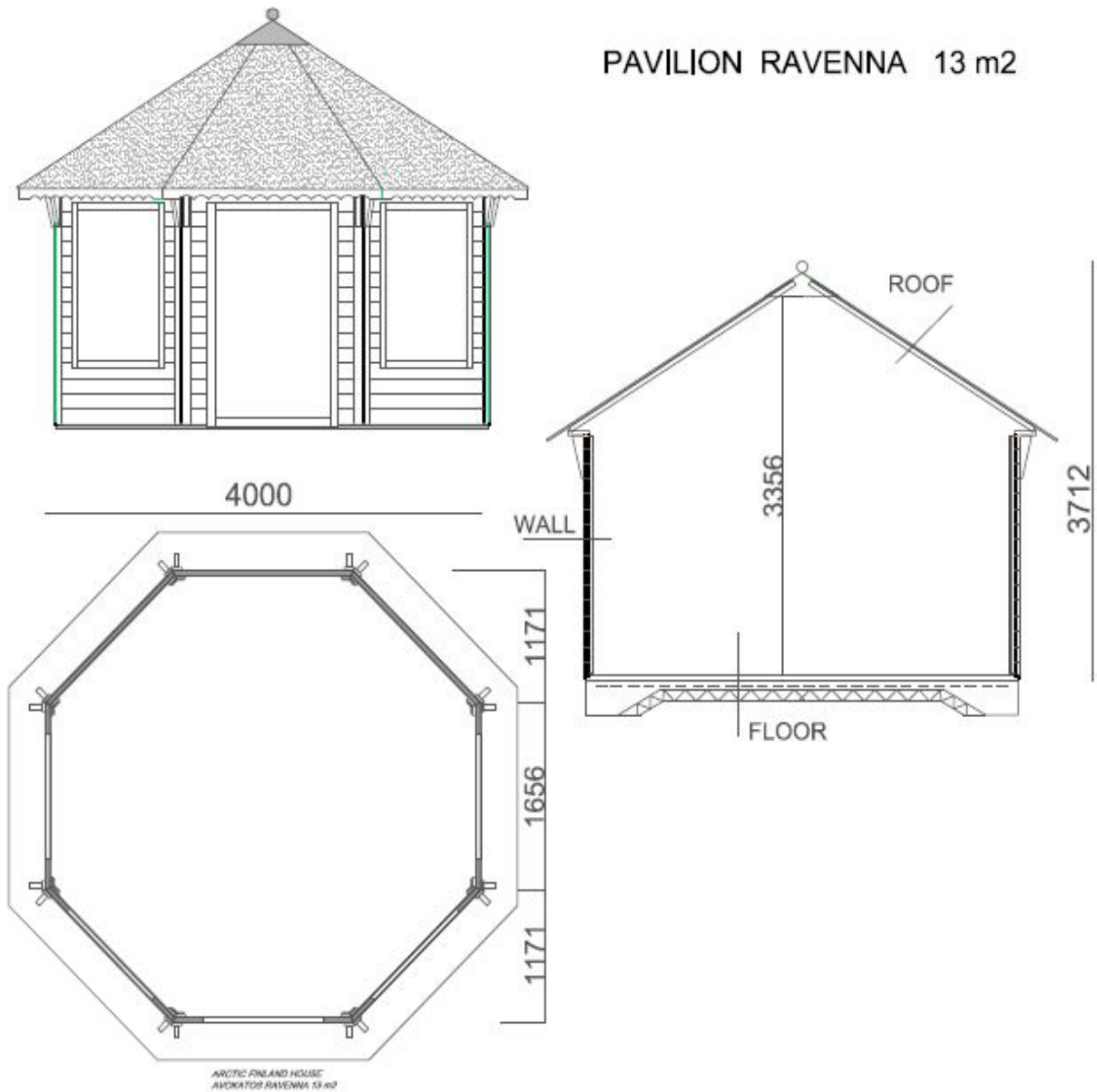

### ROOF

Roofing felt  
Panel 18 x 145  
Frame 45 x 45

### WALL

Timber panel 45 x 145

### FLOOR

Concrete slab 80 mm  
Steel mesh embedded in concrete slab  
( B500K 4-150)  
Cellular plastic / styrofoam 100 mm  
Compacted gravel 200 mm ( 0-16 mm)  
Base frame 45 x 95 pressure impregnated  
( Bitumen felt under base frame )



## 4. Foundations

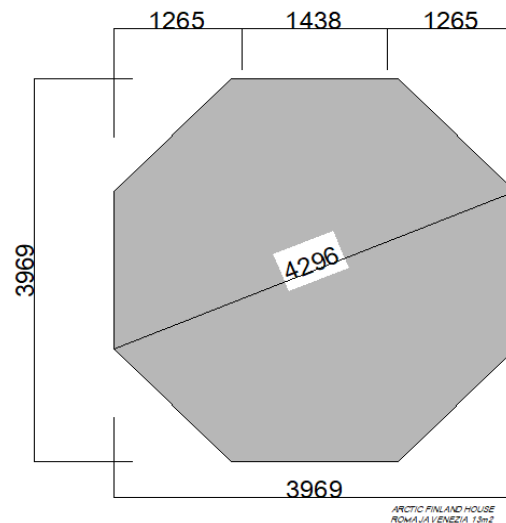

### Edge-reinforced concrete slab

1. At a depth of about 300mm, remove the surface layer of the yard, lawn, soil, etc. from a sufficiently wide area. To the excavated area, add a layer of gravel (grain size 0-16mm) about 150mm thick. Compact the gravel layer to make a level surface.
2. For the edge-reinforced foundation slab, build a formwork, e.g. from boards or plywood, with the dimensions shown in the diagram below. The height of the formwork is 200-300mm. Check the formwork dimensions carefully!
3. Embed drainage pipes outside the slab foundation to go around the building. Connect a pipe to the drainage pipe using a T connection to drain water to the sewer or to the terrain. Add gravel to the centre of the foundation and, over the levelled gravel, place a Styrofoam board 50 mm according to the drawing.
4. Use ready-mixed concrete for casting, or make the concrete yourself. First, fill in the recesses (= slab edge reinforcements) on the edges of the area with concrete and then pour the entire slab up to the top of the mold. Place a steel mesh about 30 mm below the future floor. Carefully level the concrete slab and make sure the formwork is durable!
5. Allow the concrete slab to dry well. Carefully remove the formwork without breaking the slab corners. Install the bottom tiebeam supplied with the product carefully over bitumen felt strip at the edge of the concrete slab.

Note! When laying the foundations, the soil on which to build must be taken into account. The foundations are laid according to the soil and, if necessary, following separate foundation and structural plans for which the customer is responsible. This foundation guide is for reference only.

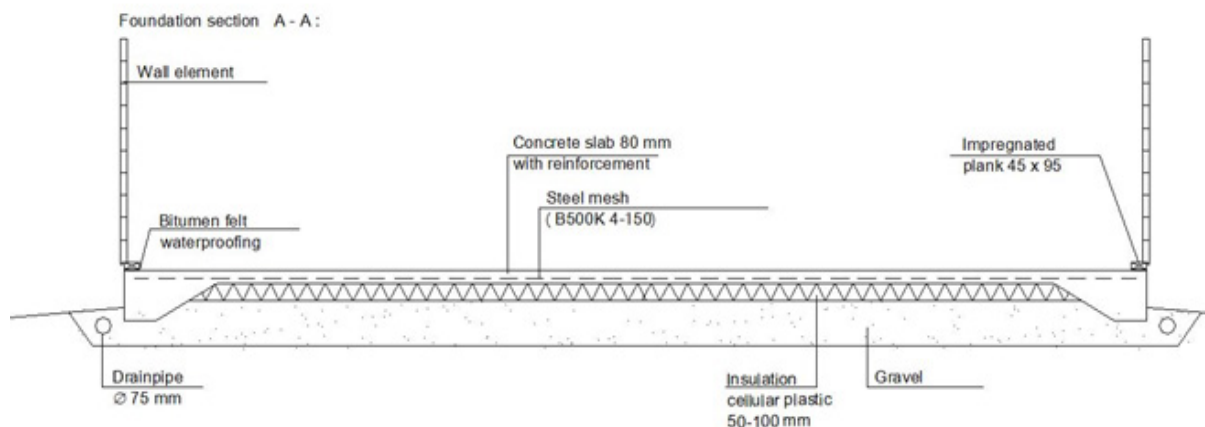

## 5. Delivery and installation

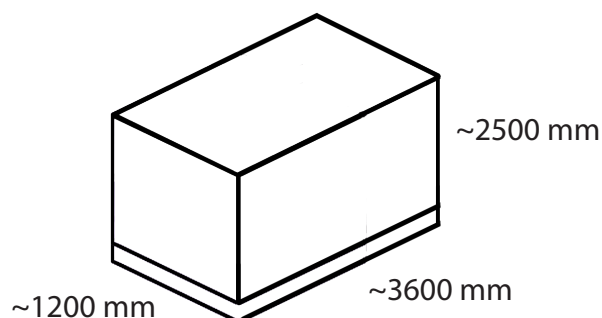
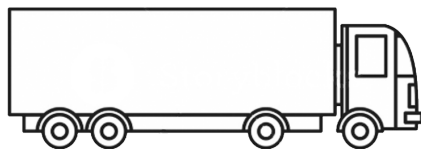

- Delivery

Package dimensions: 1,2m x 3.6m x 2,5 m / 1580kg

The Pavillon Roma and Ravenna will be delivered on the date stated in the order unless otherwise agreed or indicated. The product is brought to the end of a truck-driven road / site boundary. The product is packed on a pallet and protected with plastic. The recipient is expected to be present. Any transport damage must be recorded in the consignment note.

- Installation

The Pavillon Roma and Ravenna can be built by yourself (2 persons) on a ready-made foundation in one day using the installation instructions included in delivery. Check the contents of the package and all parts listed in the parts list. Immediately record any damaged or missing parts and contact your dealer before starting installation.

If the product is ordered with installation, it should be noted that the foundation work must be completed so that the installers can easily erect the product on the existing foundation. The installation service does not include earthworks, foundation work, painting or sheet metal cladding.

The packaging on the pallet should be less than 10 meters from the installation site. If it is further away, the customer is obliged to move or carry the parts of the product to the installation site.

The customer may also open the packaging and treat the product parts with an anti-mould agent and wood preserver prior to installation. Store the product parts off the ground on a flat surface, protected from the sun and rain. (Surface treatment of wood p. 6)

The customer is responsible for any permit procedures for the product and ascertains whether a building permit or notice to the local building control authority is required

## 6. Surface treatment of wood

The products are made of natural, good quality timber, which is an excellent building material. Thanks to its slow growth, the wood is firm, dense and straight-grained. There are few branches and the proportion of heartwood is large.

Wood is a natural material which tends to change with the weather and environmental conditions. Cracks, colour differences and other structural changes do not make the wood faulty.

The timber of the products is unprocessed. The products are stored and packed on pallets to protect them from the weather. Wood is very sensitive to sunlight and moisture, and therefore we recommend that you treat all wood components immediately or at the latest after the building is erected. The best time is during partly cloudy dry weather (over +5 degrees).

First, use a colourless wood preservative to prevent mould and blue stain. Then finish with a clear / translucent / coloured wood preservative coating or an opaque paint.

All surface treatment agents should be breathable and should not form a dense, non-breathable film on the surface of the wood. Also treat doors and windows with care on both sides.

Make sure you get the right treatment agent from your dealer. Check the wooden structures every year and perform maintenance painting on time.







**ARCTIC FINLAND HOUSE**